



Jasper Flex

Compact High Power Femtosecond Fiber Laser

Femtosecond fiber lasers superior lifetime & performance

Jasper Flex – our high-power femtosecond laser for microprocessing. Its compact size makes it easy to use and to integrate. It delivers pulses with a maximum energy of 30 μJ , up to 1 MHz repetition rate and as much as 100 μJ in the burst mode. The user-configurable burst mode brings new capabilities in industries manufacturing consumer electronics, integrated photonics, and displays. Contrary to free-space lasers, our all-fiber, SESAM-free technology ensures unbeatable beam pointing stability resulting in an outstanding lifetime even in a harsh environment.

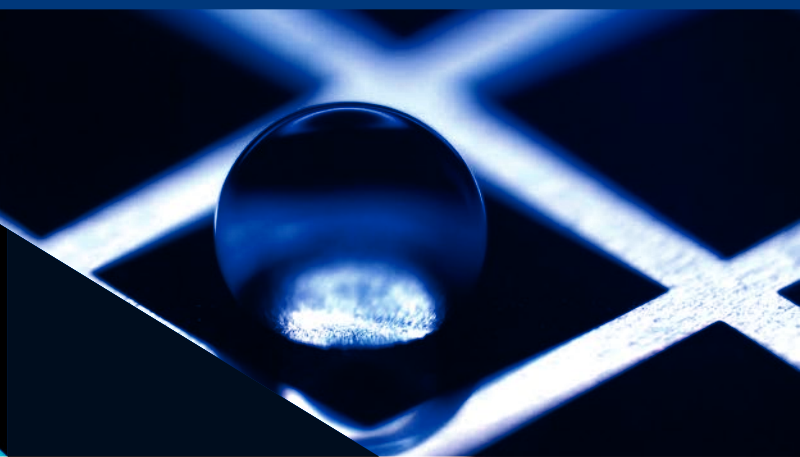
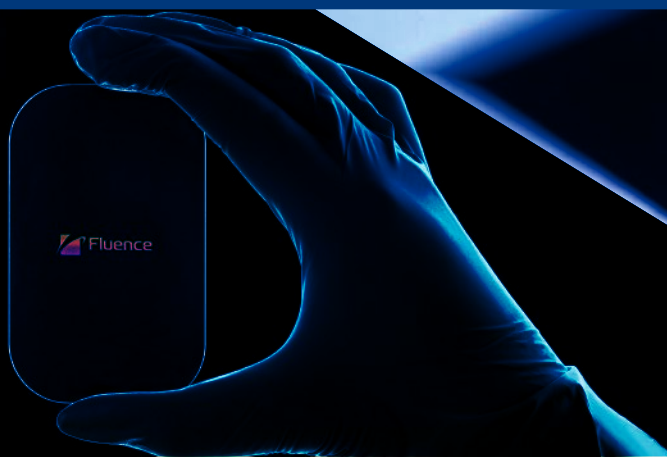

Technical specification:

Maximum average power	30 W (ask for higher)
Maximum pulse energy	30 μ J up to 1 MHz (ask for higher)
Maximum burst energy	100 μ J @ 200 kHz, 1030 nm
Base repetition rate	20 \pm 2 MHz
Two stage repetition rate tuning, selectable with control software	1 - 20 MHz, internal repetition rate Single Pulse - 1 MHz, realized with built-in pulse picker.
Pulse duration	< 270 fs FWHM (< 250 fs typical)
Pulse duration tuning	< 270 fs - 8 ps, software-controlled (< 270 fs - 20 ps optional)
Central wavelength	1030 \pm 5 nm
Optional wavelength outputs	With Harmonic Generation Module (HGM): 515 nm, 343 nm, 258 nm (available upon request)
Polarization	Linear, vertical
Beam quality M^2	< 1.3 (< 1.15 typical)
Output beam waist diameter $1/e^2$	2.0 \pm 0.5 mm (ask for other)
Burst mode for process enhancement	Included
6U, 19" rack-mountable chiller	Included
External gating trigger	Included
External analog power modulation	Included
Laser control software	Included
Pulse on demand	Included

Not exactly what you are looking for?
Get in touch with us and let us help you out.

Physical specification:

Size	646 (L) x 416 (W) x 111 (H) mm ³
Power supply unit size	3U rack: 485 (W) x 496 (D) x 133 (H) mm ³
Electrical	100 - 240 V AC, 50 - 60 Hz, < 300 W
Operating temperature	15 - 35°C
Operating humidity	Non-condensing
Chiller size	6U 19" rack unit: 485 (W) x 653 (D) x 267 (H) mm ³

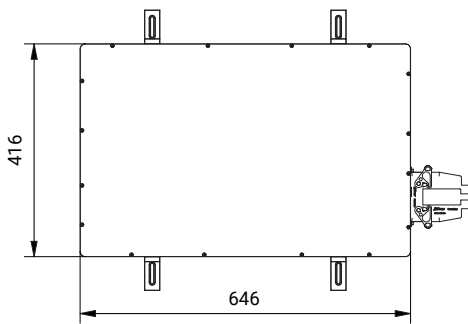
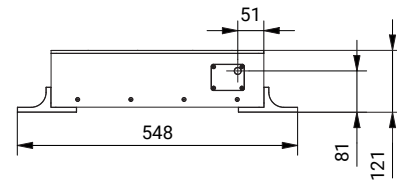
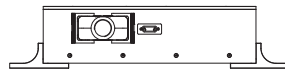
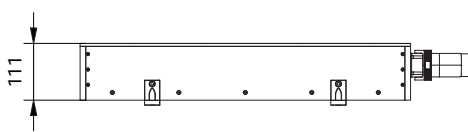

All dimensions in mm

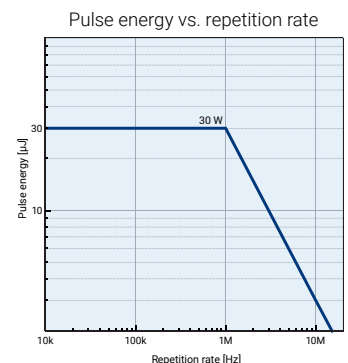
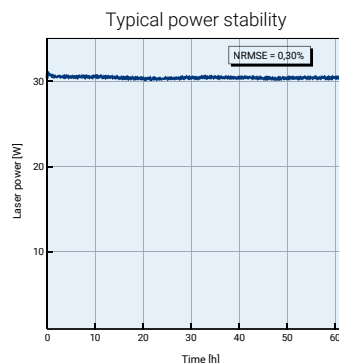
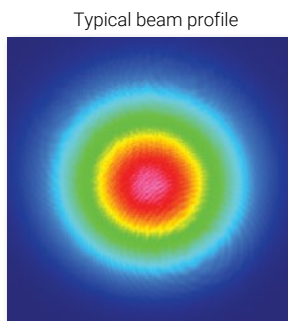
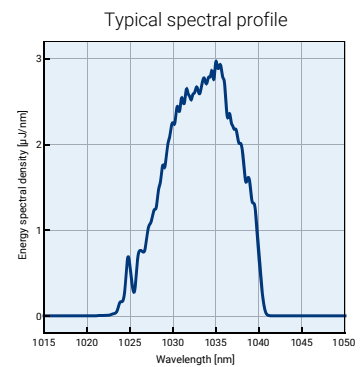
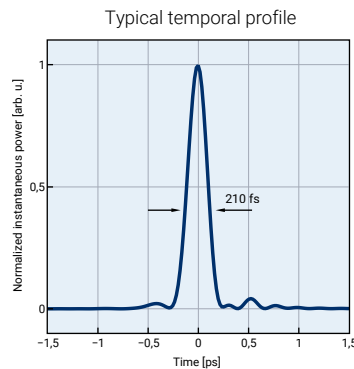

All specifications are subject to change without prior notice due to continuous improvements.